

# WAGO Power Supply Eco 2

1-phase; 24 VDC; 5 A; 120 W

2687-2144



© 2024 WAGO GmbH & Co. KG  
All rights reserved.

**WAGO GmbH & Co. KG**

Hansastraße 27  
D - 32423 Minden

Phone: +49 571/887 – 0  
Fax: +49 571/887 – 844169  
E-Mail: ✉ [info@wago.com](mailto:info@wago.com)  
Internet: 🌐 [www.wago.com](http://www.wago.com)

**Technical Support**

Phone: +49 571/887 – 44555  
Fax: +49 571/887 – 844555  
E-Mail: ✉ [support@wago.com](mailto:support@wago.com)

Every conceivable measure has been taken to ensure the accuracy and completeness of this documentation. However, as errors can never be fully excluded, we always appreciate any information or suggestions for improving the documentation.

E-Mail: ✉ [documentation@wago.com](mailto:documentation@wago.com)

We wish to point out that the software and hardware terms as well as the trademarks of companies used and/or mentioned in the present manual are generally protected by trademark or patent.

**WAGO is a registered trademark of WAGO Verwaltungsgesellschaft mbH.**

# Table of Contents

<b>1 Provisions .....</b>	<b>5</b>
1.1 Intended Use .....	5
1.2 Typographical Conventions .....	6
1.3 Legal Information .....	8
<b>2 Safety .....</b>	<b>9</b>
2.1 General Safety Regulations .....	9
2.2 Electrical Safety .....	9
2.3 Mechanical Safety .....	9
2.4 Thermal Safety .....	10
2.5 Indirect Safety .....	10
<b>3 Properties .....</b>	<b>11</b>
3.1 Overview .....	11
3.2 View .....	12
3.3 Product Identification .....	13
3.3.1 Type label .....	13
3.4 Connections .....	13
3.4.1 Connectors .....	13
3.4.1.1 Connectors Input .....	14
3.4.1.2 Connectors Output .....	14
3.5 Control Elements .....	15
3.5.1 Potentiometers .....	15
3.6 Indicators .....	15
3.7 Technical Data .....	15
3.7.1 Product .....	15
3.7.2 Input .....	16
3.7.3 Output .....	17
3.7.4 Efficiency/Power Loss .....	18
3.7.5 MTBF/Lifespan .....	19
3.7.6 Umgebungsanforderungen .....	19
3.7.7 Product Protection .....	20
3.7.8 Safety .....	20
3.8 Guidelines, approvals and standards .....	20
3.8.1 Guidelines, approvals and standards .....	20
<b>4 Planning .....</b>	<b>21</b>
4.1 Mounting Positions and Clearances .....	21
4.2 EMC Installation .....	21
4.3 Inrush Current .....	21
4.4 Parallel Mode .....	21
4.5 Derating (temperature-dependent) .....	21
4.6 Short-Circuit and Overload Behavior .....	22
<b>5 Transport and Storage .....</b>	<b>24</b>
<b>6 Installation and Removal .....</b>	<b>25</b>
6.1 DIN-35 Rail .....	25
<b>7 Connection .....</b>	<b>28</b>

---

7.1	Connectors .....	28
7.1.1	Conductor Termination .....	28
<b>8</b>	<b>Operation .....</b>	<b>30</b>
8.1	Setting the Output Voltage via Potentiometer .....	30
<b>9</b>	<b>Notes on Operation .....</b>	<b>31</b>
9.1	Parallel Connection .....	31
<b>10</b>	<b>Decommissioning .....</b>	<b>32</b>
10.1	Disposal and Recycling .....	32
<b>11</b>	<b>Appendix .....</b>	<b>33</b>
11.1	Accessories .....	33
11.2	Protected Rights .....	33

# 1 Provisions

This document applies to the following product:

2687-2144 (WAGO Power Supply Eco 2)

Product detail page	<a href="https://www.wago.com/2687-2144">www.wago.com/2687-2144</a>
---------------------	---

The product must only be installed and operated in accordance with the operating instructions. Knowledge of the operating instructions is required for proper use. You can find all documents and information on the detailed product page.

## 1.1 Intended Use

The product supplies electrical or electronic devices with DC voltage, such as industrial controllers or display, communication and measurement devices.

The product is an open type device and is designed for installation in an additional enclosure.

- The product is designed for use in dry indoor rooms.
- Operation of the products in industrial area is permitted.
- The product meets the EMC requirements for the residential, office and commercial area as well as small business, if the product used complies with the required emissions of interference (emission limits).
- Operation of the product in other application areas is only permitted when corresponding approvals and labeling are present.

### Improper Use

Improper use of the product is not permitted. Improper use occurs especially in the following cases:

- Non-observance of the intended use
- Use without protective measures in an environment in which moisture, salt water, salt spray mist, dust, corrosive fumes, gases, direct sunlight or ionizing radiation can occur
- Use of the product in areas with special risk that require continuous fault-free operation and in which failure of or operation of the product can result in an imminent risk to life, limb or health or cause serious damage to property or the environment (such as the operation of nuclear power plants, weapons systems, aircraft and motor vehicles)

### Warranty and Liability

The provisions of the latest WAGO General Terms and Conditions of Deliveries and Services (GTC) apply as well as the Software License Terms for Standard Software (SW-License) applicable to software products und software embedded in WAGO hardware products, both available at: [www.wago.com](https://www.wago.com).

In particular, the warranty is void if:

- The product is improperly used.
- The deficiency (hardware and software configurations) is due to special instructions.
- Modifications to the hardware or software have been made by the user or third parties that are not described in this documentation and that has contributed to the fault.

Individual agreements always have priority.

## Obligations of Installers/Operators

The installers and operators bear responsibility for the safety of an installation or a system assembled with the product. The installer/operator is responsible for the proper installation and safety of the system. All laws, standards, guidelines, local regulations and accepted technology standards and practices applicable at the time of installation, and the instructions in the the products' Instructions for Use, must be complied with. In addition, the installment requirements for licensing must be observed. In the event of non-compliance, the product may not be operated within the scope of the approval.

## 1.2 Typographical Conventions





### Number Notation

100	Decimals: Normal notation
0x64	Hexadecimals: C-notation
'100'	Binary: In single quotation marks
'0110.0100'	Nibbles separated by a period

### Text Formatting

<i>italic</i>	Names of paths or files
<b>bold</b>	Menu items, entry or selection fields, emphasis
Code	Sections of program code
>	Selection of a menu point from a menu
"Value"	Value entries
[F5]	Identification of buttons or keys

### Cross References / Links

	Cross references/links to a topic in a document
	Cross references / links to a separate document
	Cross references / links to a website
	Cross references / links to an email address

### Sequence of Action

- ✓ This symbol identifies a precondition.
- 1. Action step
- 2. Action step
  - ⇒ This symbol identifies an intermediate result.
  - ⇒ This symbol identifies the result of an action.
- Individual action step

### Lists

- Lists, first level
  - Lists, second level

## Figures

Figures in this documentation are for better understanding and may differ from the actual product design.

## Warning Messages

### **DANGER**

#### Type and source of hazard

Indicates an imminently hazardous situation which, if not avoided, will result in death or serious injury.

- Action step to reduce risk

### **WARNING**

#### Type and source of hazard

Indicates a potentially hazardous situation which, if not avoided, could result in death or serious injury.

- Action step to reduce risk

### **CAUTION**

#### Type and source of hazard

Indicates a potentially hazardous situation which, if not avoided, may result in minor or moderate injury.

- Action step to reduce risk

### **NOTICE**

#### Type and source of malfunction (property damage only)

Indicates a potentially hazardous situation which, if not avoided, may result in damage to property.

- Action step to reduce risk

## Information Notices

### **Note**

#### Information

Indicates information, clarifications, recommendations, referrals, etc.

## 1.3 Legal Information

### Intellectual property

The intellectual property of this document belongs to WAGO GmbH & Co. KG. The reproduction and distribution of its content (in whole or in part) is prohibited, unless otherwise provided by statutory provisions, written agreements or this document. In case of doubt, the written consent of WAGO GmbH & Co. KG must be obtained in advance.

Third-party products are always mentioned without any reference to patent rights. WAGO GmbH & Co. KG, or the manufacturer of third-party products, retains all rights regarding patent, utility model or design registration.

Third-party trademarks are referred to in the product documentation. The “®” and “™” symbols are omitted hereinafter. The trademarks are listed in the Appendix:  **Protected Rights [► 33]**.

### Subject to Change

The instructions, guidelines, standards, etc., in this manual correspond to state of the art at the time the documentation was created and are not subject to updating service. The installer and operator bear sole responsibility to ensure they are complied with in their currently applicable form. WAGO GmbH & Co. KG retains the right to carry out technical changes and improvements of the products and the data, specifications and illustrations of this manual. All claims for change or improvement of products that have already been delivered – excepting change or improvement performed under guarantee agreement – are excluded.



## 2 Safety

### 2.1 General Safety Regulations

- This documentation is part of the product. Therefore, retain the documentation during the entire service life of the product. Pass on the documentation to any subsequent user of the product. In addition, ensure that any supplement to this documentation is included, if necessary.
- The product must only be installed and put into operation by qualified electrical specialists per EN 50110-1/-2 and IEC 60364.
- Comply with the laws, standards, guidelines, local regulations and accepted technology standards and practices applicable at the time of installation.

### 2.2 Electrical Safety

- High voltage can cause electric shock or burns! Disconnect all power sources from the product before performing any installation, repair or maintenance.
- Make sure the product does not carry any voltage before starting work.

#### Power Supply

- Connecting impermissible current or frequency values may destroy the product.
- Provide suitable disconnect and overcurrent protection on the system side. The protection device must be located near the product where it can be operated. The **OFF** position must be clearly marked on the protection device.

#### Grounding/Protection/Fuses

- When handling the product, please ensure that environmental factors (personnel, work space and packaging) are properly equalized. Do not touch any conducting parts.
- Protect the product with an appropriate overcurrent protection device.

#### Cables

- Always design the connection cables for the maximum anticipated current load.
- High currents and the inherent heat generated by the product can cause additional heat generation at the clamping point. Plan for a correspondingly higher temperature range for the connecting cables, or reduce inherent heat by selecting larger conductor cross-sections.
- Only clamp one conductor to each connection terminal. If several conductors must be clamped, wire them using an upstream wiring assembly (e.g., WAGO Through Terminal Blocks).

### 2.3 Mechanical Safety

- Before startup, please check the product for any damage that may have occurred during shipping. Do not put the product into operation in the event of mechanical damage.
- Do not open the product housing.
- The product is an open-type device and is designed for installation in an additional enclosure, which supplies the following safety aspects:
  - Restrict access to authorized personnel and may only be opened with tools.

- Ensure the required pollution degree in the vicinity of the system.
- Offer adequate protection against direct or indirect contact.
- Offer adequate protection against UV irradiation.
- Prevent fire from spreading outside of the enclosure.
- Guarantee mechanical stability.

## 2.4 Thermal Safety

- The surface of the housing heats up during operation. Under special conditions (e.g., in the event of a fault or increased surrounding air temperature), touching the product may cause burns. Allow the product to cool down before touching it.
- The temperature inside the additional enclosure must not exceed the ambient temperature permitted for the mounted product.
- Cooling of the product must not be impaired. Ensure air can flow freely and that the minimum clearances from adjacent products/areas are maintained.

## 2.5 Indirect Safety

- Only use a dry or cloth or a clothed dampened with water to clean the product. Do not use cleaning agents, e.g., abrasive cleaners, alcohols or acetone.
- Clean tools and materials are imperative for handling the product.
- The product contains no parts that can be serviced by the user. Always have all service, maintenance and repair work performed by specialists authorized by WAGO.
- Replace any defective or damaged devices.
- Observe possible different technical specifications for mounting that does not correspond to the nominal mounting position.
- Only use accessories authorized by WAGO.

# 3 Properties

## 3.1 Overview

The WAGO Power Supplies Eco 2 Series 2687 are switched mode Power supplies with a wide range of uses. They include all important basic functions and are available in different performance classes and widths.

The Power supplies are fitted on a DIN-rail. With their slim design, they are suitable for use both in the control cabinet and in a compact distribution box.

The connection technology is made using the WAGO PCB terminal blocks with levers. These allow for quicker installation, as well as quicker and easier product replacement.

There is a potentiometer on the product for setting the output voltage.

An LED indicates the status of the output voltage (see [🔌 Indicators \[▶ 15\]](#)).

The Power supplies can withstand a wide variety of environmental conditions, such as input overvoltages or the effects of shocks and vibrations.

The Power supplies meet the EN/IEC/UL 61010-2-201 standards.

### 3.2 View

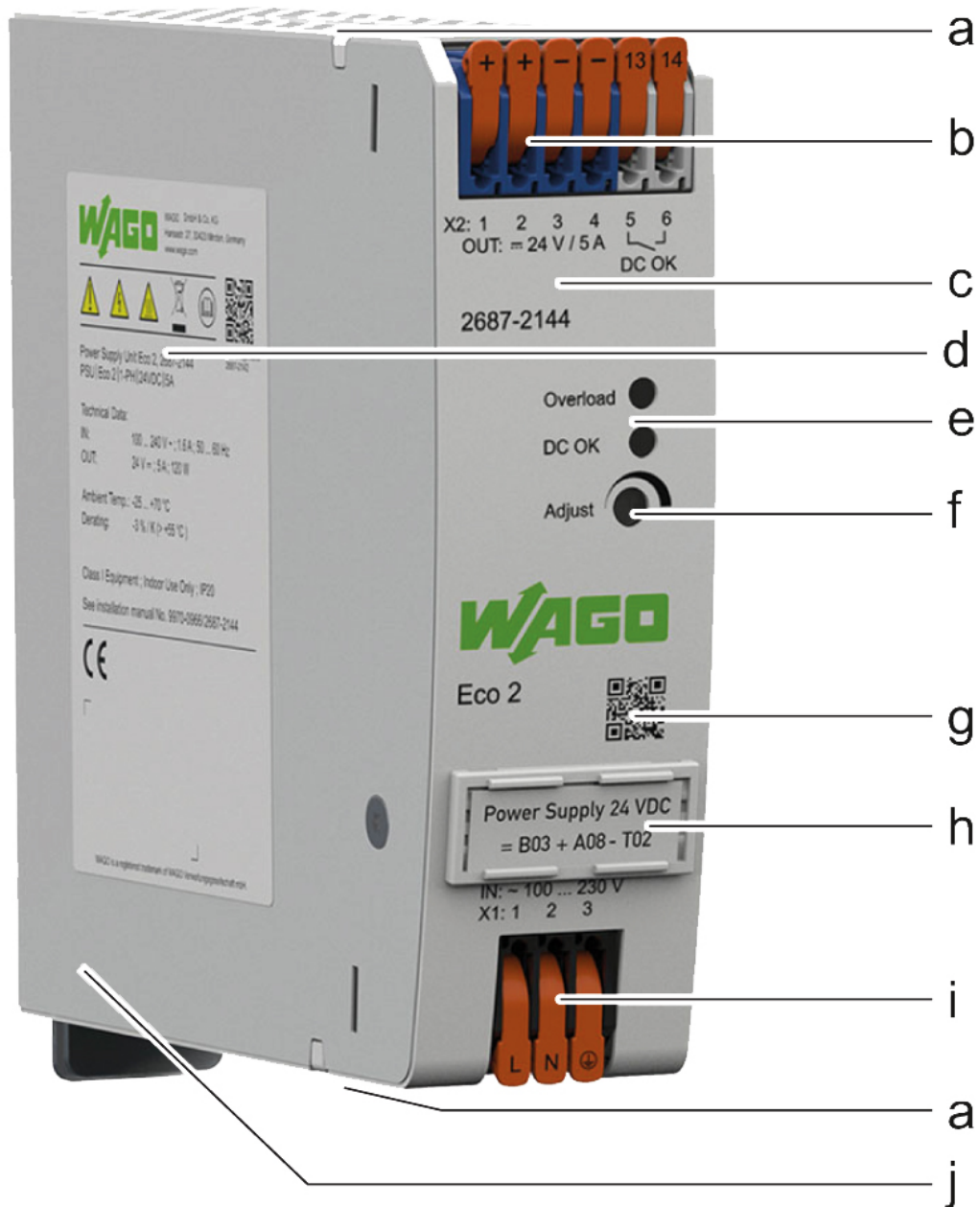

Figure 1: View

a	Ventilation openings	
b	Output X2 (+ - - 13 14)	<a href="#">Connectors [▶ 13]</a>
c	Front side	
d	Type label	<a href="#">Type label [▶ 13]</a>
e	LED indicator	<a href="#">Indicators [▶ 15]</a>
f	Potentiometer for setting the output voltage	<a href="#">Control Elements [▶ 15]</a>
g	QR code	
h	Marker carrier	<a href="#">Accessories [▶ 33]</a>
i	Input X1 (L N)	<a href="#">Connectors [▶ 13]</a>

j	Latch for mounting to /removal from DIN rail	
---	--	--

### 3.3 Product Identification

#### 3.3.1 Type label

The product's type plate contains the following information:

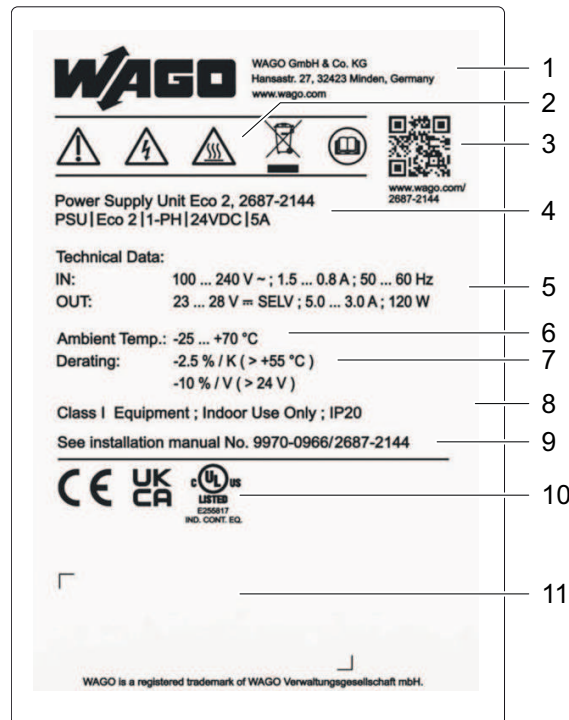

1	Company logo and address	
2	Warning notice symbols	<a href="#">Safety [▶ 9]</a>
3	QR link with link to website	
4	Product name and order number	
5	Input and output data	<a href="#">Technical Data [▶ 15]</a>
6	Surrounding air temperature	<a href="#">Umgebungsanforderungen [▶ 19]</a>
7	Derating information	<a href="#">Derating (temperature-dependent) [▶ 22]</a>
8	Additional technical data	<a href="#">Technical Data [▶ 15]</a>
9	Information on the instruction leaflet	
10	Field for guidelines, approvals and standards	<a href="#">Guidelines, approvals and standards [▶ 20]</a>
11	Label with product-specific information	

### 3.4 Connections

#### 3.4.1 Connectors

The supply lines are connected on the input and output side using the WAGO PCB terminal blocks with levers:

- Input side: 3-pole
- Output side: 6-pole

Note the maximum permissible connection cross-sections of the power cables (see [Input \[▶ 16\]](#)).

Check the associated operating voltage before connecting the equipment (see [Type label \[▶ 13\]](#)).

For additional information on the connection technology, see [Connect \[▶ 28\]](#).

Table 1: Connectors

	Input	Output	Contact "DC OK"
WAGO PCB Terminal Block with Lever	2604-1103	2604-1104	2604-1102
Contact	3-pole: "L", "N" and "PE"	4-pole: twice "+" and "-"	2-pole "13" and "14"

### 3.4.1.1 Connectors Input

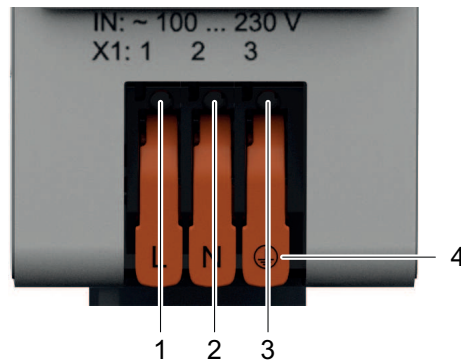

Figure 2: Connection Input X1

1	Contact "L" for Input voltage
2	Contact "N" for Input voltage
3	Contact "PE" for ground conductors
4	Lever

### 3.4.1.2 Connectors Output

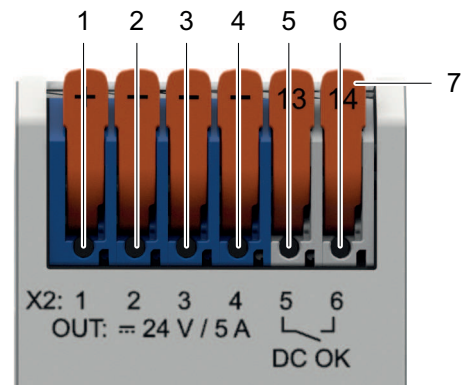

Figure 3: Connection Output X2

1	Contact 1 "+" for output voltage
2	Contact 2 "+" for output voltage
3	Contact 3 "-" for output voltage
4	Contact 4 "-" for output voltage

5	Contact 5 "13" for DC OK
6	Contact 6 "14" for DC OK
7	Lever

### 3.5 Control Elements

The control elements are described below.

For information on using these controls, see [🔗 Operation \[▶ 30\]](#).

#### 3.5.1 Potentiometers

A potentiometer is located on the front of the product for setting or adjusting the output voltage.

The potentiometer can be used to set the output voltage between 23 ... 28 VDC.

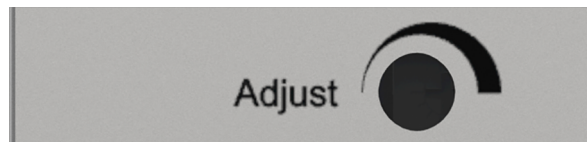

Figure 4: Potentiometer

### 3.6 Indicators

The indicators are located on the front of the product.

The "DC OK" LED indicates the status of the output voltage  $U_{OUT}$ .

The "Overload" LED indicates the overload status.

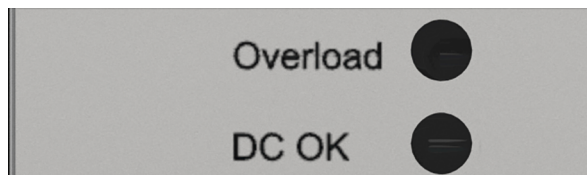

Figure 5: LED "Overload" and LED "DC OK"

LED	Description	Status	Explanation
DC OK	■	AN	Output voltage $\geq 21$ V
Overload	■	Overload on	Constant power up to 125 %

### 3.7 Technical Data

#### 3.7.1 Product

Table 2: Technical Data – Product

Property	Value
Width	38 mm
Height	130 mm
Depth from upper-edge of DIN-rail	131 mm
Weight	650 g

Property	Value
Degree of Protection	IP20



Figure 6: Dimensions

**Note**

**Observe mounting position!**

The following electrical data refers to the nominal mounting position (see [Mounting Positions and Clearances \[▶ 21\]](#)).

**3.7.2 Input**

Table 3: Technical Data – AC Input

Property	Value
Nominal input voltage	1 × 100 ... 240 VAC
Input voltage range	90 ... 264 VAC
Input frequency	50 ... 60 Hz
Grounding systems	TN, TT and IT networks
Input current (typ.) <sup>1)</sup>	110 VAC ≤ 1.5 A
	230 VAC ≤ 0.8 A
Power factor (typ.) <sup>1)</sup>	> 0.85

<sup>1)</sup> At nominal load.

Table 4: Technical Data – DC Input

Property	Value
Nominal input voltage <sup>1)</sup>	90 ... 300 VDC
Input voltage range	90 ... 300 VDC ( < 110 VDC Derating necessary –1.5 %/ VDC)



Property		Value
Input current (typ.) <sup>2)</sup>	110 VDC	< 1.30 A
	220 VDC	< 0.65 A

<sup>1)</sup> An external DC fuse must be used for DC power supply (see [Accessories \[p. 33\]](#)).

<sup>2)</sup> At nominal load.

Table 5: Technical Data – Inrush Current

Property		Value
Inrush current (typ.) <sup>1)2)</sup>	230 VAC	≤ 10 A (after 1 ms)

<sup>1)</sup> Cold start, at room temperature of 25 °C.

<sup>2)</sup> After 1 ms at nominal load.

Table 6: Technical Data – Mains Failure Buffering Time

Property		Value
Mains failure buffering time, typ. <sup>1)</sup>	110 VAC	≥ 20 ms
	230 VAC	≥ 25 ms
Holding time, typ. <sup>1)</sup>	110 VAC	≥ 40 ms
	230 VAC	≥ 40 ms

<sup>1)</sup> At nominal load.

Table 7: Technical Data – Input Side Connection

Property		Value
Connection type		2604 Series
Querschnitt	Solid	0.2 ... 4 mm <sup>2</sup> / 24 ... 12 AWG
	Fine-stranded	0.2 ... 4 mm <sup>2</sup> / 24 ... 12 AWG
	Insulated ferrule with plastic collar	0.25 ... 2.5 mm <sup>2</sup> / 22 ... 14 AWG
	Insulated ferrule without plastic collar	0.25 ... 2.5 mm <sup>2</sup> / 22 ... 14 AWG
Strip length		9 ... 11 mm / 0.35 ... 0.43 inch
Required tools (conductor termination)		None

### 3.7.3 Output

Table 8: Technical Data – Output

Property		Value
Nominal output voltage $U_{OUT}$		24 VDC (at 90 ... 264 VAC), SELV
Output voltage range		23 ... 28 VDC
Factory settings		24 VDC; ±1 %
Output current $I_{OUT}$		5 A (at 100 ... 240 VAC)
Output power <sup>1)</sup>		120 W (at 100 ... 240 VAC)
Power factor <sup>2)</sup>		> 0.85
Voltage variation		±1 % (at 100 ... 240 VAC)
Derating of output power		For high ambient temperature, see <a href="#">Derating (temperature-dependent) [p. 22]</a> .
Line regulation <sup>2)</sup>		±0.5 %
Load regulation <sup>3)</sup>		±1 %
Residual ripple/noise		≤ 75 mV (peak-to-peak, at 230 VAC)
Overload behavior <sup>4)</sup>		Constant power up to 125 % Shutdown and automatic restart in the event of a short circuit <sup>5)</sup>
Switch-on delay <sup>6)</sup>	110 VAC	< 1900 ms <sup>2)</sup>
	230 VAC	< 1800 ms <sup>2)</sup>

Property	Value
----------	-------

- <sup>1)</sup> In nominal mounting position (see [Mounting Positions and Clearances \[▶ 21\]](#)).
- <sup>2)</sup> At nominal load.
- <sup>3)</sup> 0 % / 100 % load step.
- <sup>4)</sup> See [Short-Circuit and Overload Behavior \[▶ 22\]](#).
- <sup>5)</sup> See figure "Hiccup-Mode" in [Short-Circuit and Overload Behavior \[▶ 22\]](#);  
 $t_{on} = < 155 \text{ ms} / t_{off} = \text{approx. } 800 \text{ ms}$ .
- <sup>6)</sup> See figure "Turn-on time" in [Short-Circuit and Overload Behavior \[▶ 22\]](#).

Table 9: Technical Data – Contact Output

Property	Value	
Connection Technology	2604 Series	
Cross-section	Solid	0.2 ... 4 mm <sup>2</sup> / 24 ... 12 AWG
	Fine-stranded	0.2 ... 4 mm <sup>2</sup> / 24 ... 12 AWG
	Insulated ferrule with plastic collar	0.25 ... 2.5 mm <sup>2</sup> / 22 ... 14 AWG
	Ferrule without plastic collar	0.25 ... 2.5 mm <sup>2</sup> / 22 ... 14 AWG
Strip length	9 ... 11 mm / 0.35 ... 0.43 inch	

### 3.7.4 Efficiency/Power Loss

Table 10: Technical Data – Efficiency/Power Loss

Property	Value	
Efficiency (typ.) <sup>1)</sup>	110 VAC	86 %
	230 VAC	90 %
Power Loss	110 VAC	< 1.2 W (no load), ≤ 19 W (nominal load)
	230 VAC	< 1.1 W (no load), ≤ 13 W (nominal load)

<sup>1)</sup> At nominal load

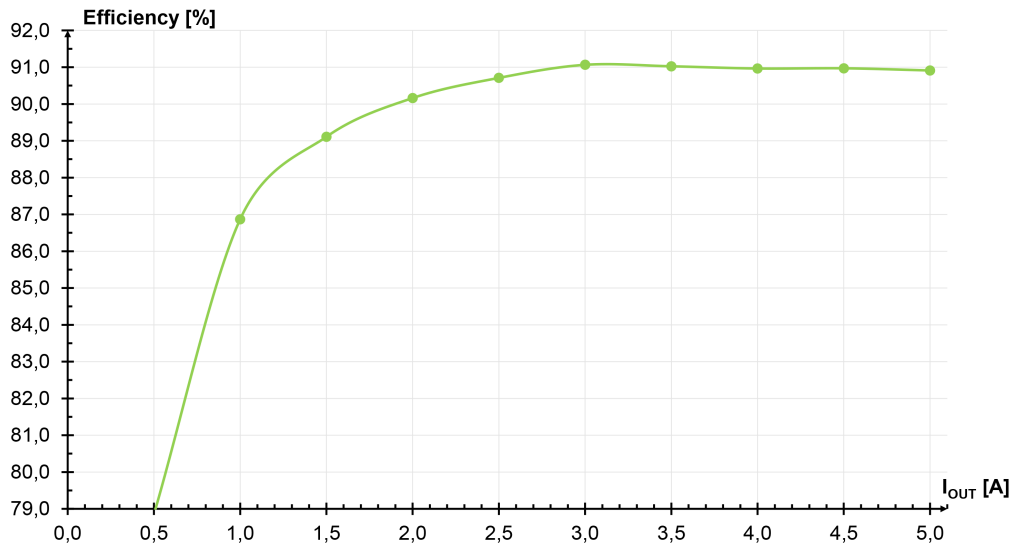

Figure 7: Efficiency at 230 VAC

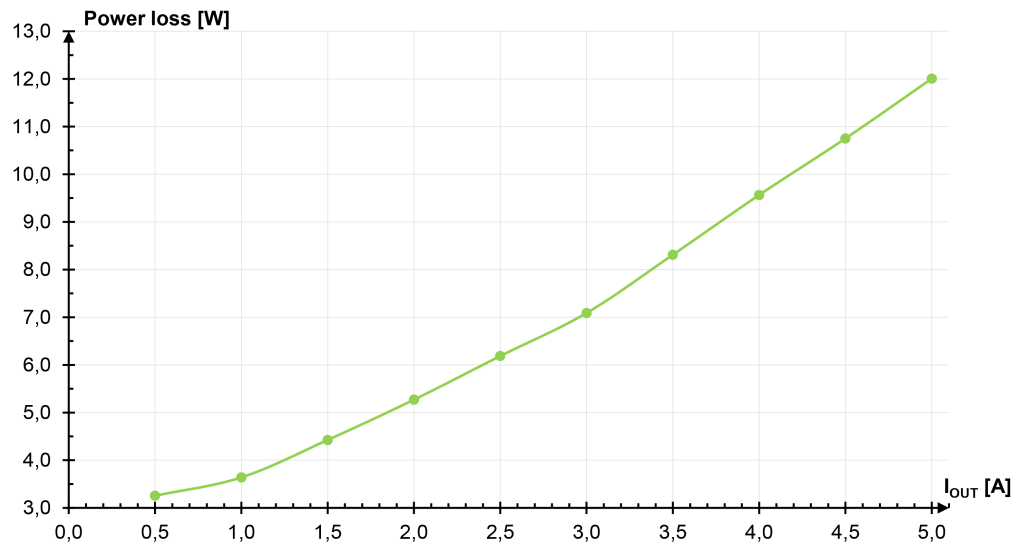

Figure 8: Power loss at 230 VAC

### 3.7.5 MTBF/Lifespan

Table 11: Technical Data – MTBF/Lifespan

Property	Ambient temperature	Value
MTBF (IEC 61709)	+ 25 °C	> 700000 h

### 3.7.6 Umgebungsanforderungen

Table 12: Technical Data – Environment requirements

Property	Value
Ambient temperature, operation	-25 ... +70 °C (device starts at -40 °C, type-tested)
Derating (temperature-dependent)	-2.5 %/K (> +55 °C) <sup>1)</sup>
Relative humidity	5 ... 96 % (no condensation permissible)
Ambient temperature, storage	-40 ... +85 °C
Relative humidity, storage (without condensation)	5 ... 96 % (no condensation permissible)
Temperature coefficient	≤ ±0.005 %/K
Derating (voltage)	-10 %/VDC (> 24 VDC)
Operating altitude above sea level, max.	5000 m
Overvoltage category	III (≤ 2000 m a. s.l.) II (> 2000 m a. s.l.)
Vibration according to IEC 60068-2-6	5 Hz ≤ f ≤ 8.4 Hz: 3.5 mm . 8.4 Hz ≤ f ≤ 150 Hz: 1 g
Shock according to IEC 60068-2-27	15g, 11 ms, 3 shocks per axis (18 shocks in total)
Pollution degree according to IEC/EN 60664-1	2
Climate category	3K3 (per EN 60721)
LABS freedom <sup>2)</sup>	Yes
RoHS II / Reach	Yes

<sup>1)</sup> Siehe [Derating \(temperature-dependent\) \[▶ 22\]](#).

<sup>2)</sup> LABS = Paint-wetting impairment substances

The materials used in manufacturing do not contain any substances harmful to the wetting properties of lacquers.

#### See also

 Derating (temperature-dependent) [[▶ 22](#)]

### 3.7.7 Product Protection

Table 13: Technical Data – Product safety

Property	Value
Internal input fuse <sup>1)</sup>	T 3.15 A / 250 VAC
Transient suppression at input	Varistor
Overload protection at output	Load limited to max. 140 % of the nominal load
Overvoltage protection at output (max.) <sup>2)</sup>	≤ 33 VDC
Feedback voltage (max.) <sup>3)</sup>	Yes, max. 35 VDC
Protection Type	IP20
Ingress protection against foreign objects	≥ 5 mm
Overtemperature protection <sup>4)</sup>	Yes
Short circuit protection <sup>4)</sup>	Yes

<sup>1)</sup> Used only as an AC fuse. An external DC fuse must be used with DC supply (see [🔗 Accessories \[▶ 33\]](#)).

<sup>2)</sup> Internal limitation via a second control loop, deactivation of power supply, automatic restart.

<sup>3)</sup> The installer/operator must ensure that the voltage is not exceeded for power feedback.

<sup>4)</sup> Shutdown, automatic restart.

### 3.7.8 Safety

Table 14: Technical Data – Safety

Property	Value
Safety transformer	Per EN 61558-2-16
Input and output insulation, gemäß EN 62368-1	SELV/PELV
Protection class, with protective wire connection per EN/UL 61010-2-201	I
Leakage current (max.) <sup>1)</sup>	≤ 0.25 mA
Insulation resistance, input to output (min.) <sup>2)</sup>	> 100 MΩ / 500 VDC
Dielectric strength (input – output) <sup>3)</sup>	3600 kVAC

<sup>1)</sup> For power at 230 VAC.

<sup>2)</sup> At 25 °C and 75 % relative humidity.

<sup>3)</sup> Type testing / 60 s

## 3.8 Guidelines, approvals and standards

### 3.8.1 Guidelines, approvals and standards

The applicable guidelines, approvals and standards for the product can be found on the product detail page at: [🌐 www.wago.com/2687-2144](https://www.wago.com/2687-2144).

# 4 Planning

## 4.1 Mounting Positions and Clearances

Table 15: Technical Data – Minimum Clearances

Mounting Directions	Front Side	Clearance from					
		Front	Back	Top	Bottom	Left	Right
Vertical <sup>1)</sup>	Front	70 mm	-	70 mm	70 mm	6 mm	6 mm
Horizontal	Top	70 mm	70 mm	70 mm	-	20 mm	20 mm
Horizontal	Bottom	70 mm	70 mm	-	70 mm	20 mm	20 mm

<sup>1)</sup> Nominal mounting position (top and bottom ventilation slots; legible marking)

The following values must not be exceeded when mounting with the front side up or down:

Table 16: Max. Values for horizontal installation

Max. Output power	Max. Ambient temperature
50 %	55 °C

## 4.2 EMC Installation

- **Compliance with EMC interference emission standards**

To comply with EMC interference standards, the cable length of the DC output must not exceed 30 m.

## 4.3 Inrush Current

If several products are connected in parallel and supplied on the input side using the same circuit, higher inrush currents can result. In this case, the use of auxiliary relays, which cause a time delay in startup, is recommended.

The maximum number of products that can be switched on at the same time depends, among other things, on the backup fuse used and the impedance of the supply network.

## 4.4 Parallel Mode

The maximum number of products that can be operated in parallel on one circuit is given by the sum of the leakage currents. According to EN 62368-1, this sum must not exceed the maximum value of 3.5 mA.

## 4.5 Derating (temperature-dependent)

Depending on the ambient temperature, it may be necessary to reduce the load.

Table 17: Derating (Temperature-Dependent)

Ambient Temperature	Derating
> +55 °C	-2.5 %/K (> +55 °C)

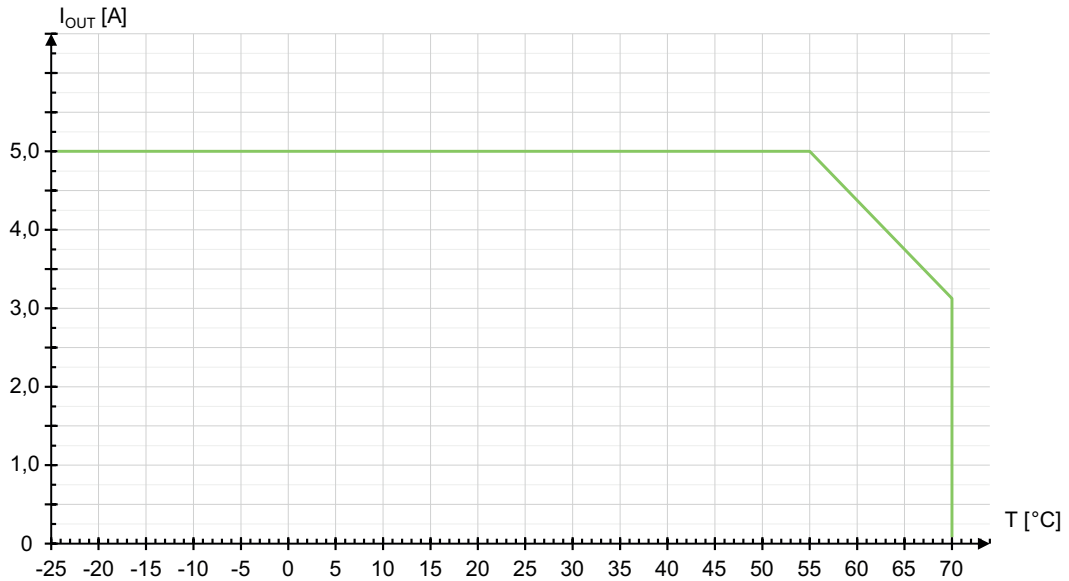

Figure 9: Derating (Temperature-Dependent)

### 4.6 Short-Circuit and Overload Behavior

The output of the product is electronically protected against overload and short circuit.

The following values apply to the description below:

- I<sub>OUT</sub> Nominal output current (see [Technical Data \[p 15\]](#))
- I<sub>OUT(IST)</sub> Actual output current
- U<sub>OUT</sub> Output voltage (see [Technical Data \[p 15\]](#))

In the event of an overload, the output current is limited to a value of  $I_{OUT} < I_{OUT(IST)} < 1,25 \times I_{OUT}$ .

In the event of a short circuit, the output voltage U<sub>OUT</sub> is switched off. The product checks whether the short circuit is still present through cyclical re-activation of the output voltage (Hiccup mode: t<sub>on</sub> = < 155 ms / t<sub>off</sub> = approx. 800 ms; see also [Output \[p 17\]](#)). Short circuit current is I<sub>OUT</sub> ≥ 10.5 A in Hiccup mode.

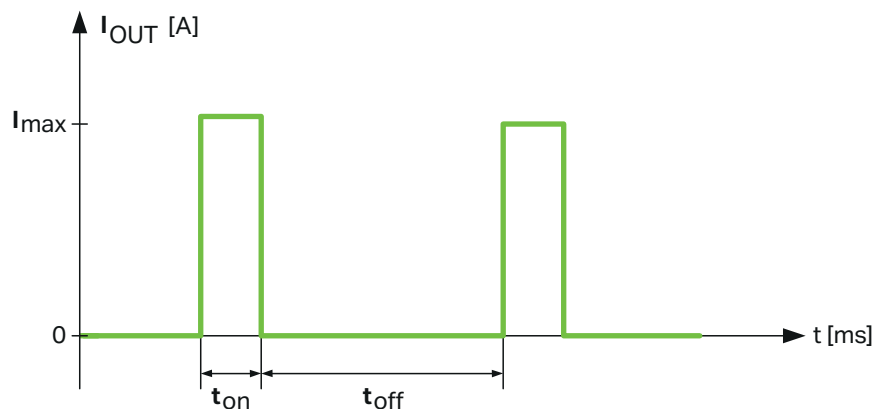

Figure 10: Hiccup-Mode

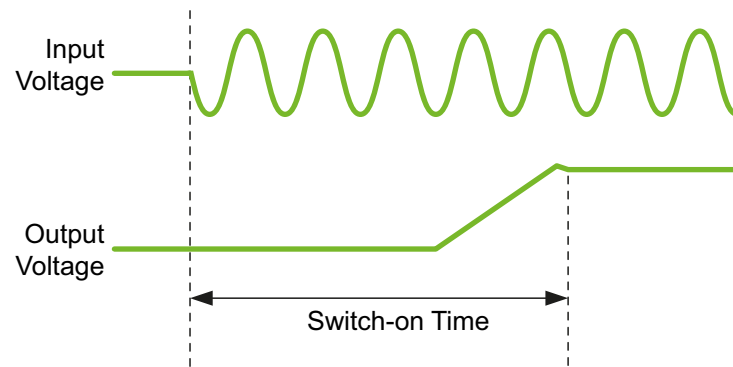

Figure 11: Turn-on time

After eliminating the overload or short circuit, the product automatically supplies the output voltage as indicated.

## 5 Transport and Storage

The original packaging offers optimal protection during transport and storage.

- Store the product in suitable packaging, preferably the original packaging.
- Only transport the product in suitable containers/packaging.
- Make sure the product contacts are not contaminated or damaged during packing or unpacking.
- Observe the specified ambient climatic conditions for transport and storage.



## 6 Installation and Removal

The product can either be mounted on a DIN-35 rail or alternatively by means of a screw mount.

### ! NOTICE

#### Avoid electrostatic discharge!

The products are equipped with electronic components that you may destroy by electrostatic discharge when you touch. Please observe the safety precautions against electrostatic discharge in accordance with EN 61340-5-1/-3. Pay attention while handling the products to good grounding of the environment (persons, job and packing).

### 6.1 DIN-35 Rail

The DIN rail is located in the center of the vertical axis (see [🔗 Technical Data \[p 15\]](#)).

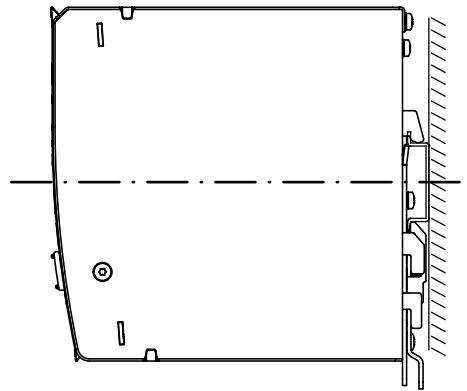

Figure 12: Position of the DIN Rail

The distances from the central axis of the DIN rail to the top and bottom are 50 mm.

#### Mounting on the DIN Rail

Mount the product per EN 60715 by snapping it onto the DIN rail without any tools.

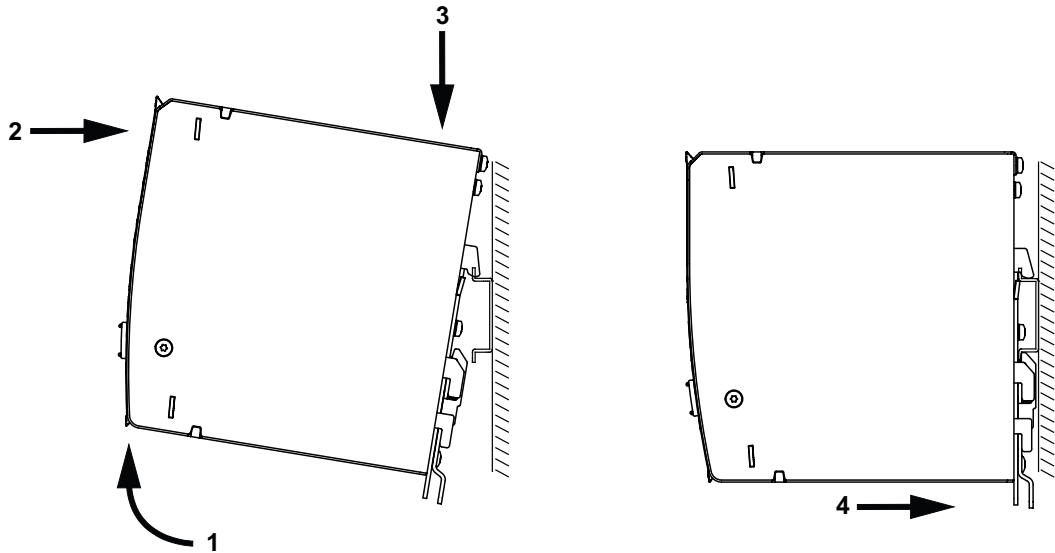

Figure 13: Mounting the Product on the DIN rail

1. Tilt the product slightly.
2. Place the product, with its DIN rail guide, on the top edge of the DIN rail.
3. Press the product onto the DIN rail.
4. Press the product against the bottom fastener until you hear it lock into place.
  - ⇒ If the product does not lock into place automatically, pull down the DIN rail mounting/removal latch with a screwdriver or operating tool while pressing the product onto the bottom fastener.
5. Gently shake the product to ensure that it is correctly locked into place.
6. To ensure secure fastening on the DIN rail, fit end clips on either side of the product (with a block arrangement: on either side of the product).

### Removing from the DIN Rail

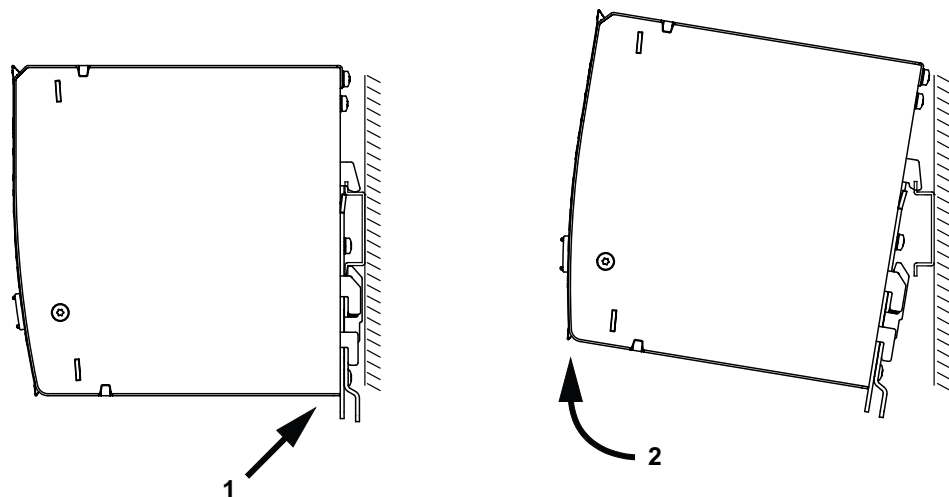

Figure 14: Removing the Product from the DIN Rail

1. To remove the product, pull down the DIN rail mount/removal latch.
  - ⇒ Use a screwdriver or an operating tool.
  - ⇒ The product is now unlocked.

2. Tilt the product forward and unhook it from the DIN rail.

# 7 Connection

## DANGER

### Do not work on products while energized!

High voltage can cause electric shock or burns!

- Disconnect all power sources from the product before performing any installation, repair or maintenance.

Note the maximum permissible connection cross-sections of the power cables (see [🔗 Technical Data \[▶ 15\]](#)).

Check the associated operating voltage before connecting the equipment (see [🔗 Type label \[▶ 13\]](#)).

Use only the recommended tools (see [🔗 Accessories \[▶ 33\]](#)).

## 7.1 Connectors

### 7.1.1 Conductor Termination

If multiple conductors must be laid on one connection, connect them in an upstream wiring assembly, e.g., using WAGO Through Terminal Blocks.

#### Direct Insertion of Conductors

The following conductors can be inserted directly without tools:

- Fine-stranded conductors with ferrules and plastic collars for all permissible cross-sections
- Fine-stranded conductors with ferrules without plastic collars with a cross-section  $> 0.5 \text{ mm}^2 / 20 \text{ AWG}$
- Solid conductors with a cross section  $> 0.25 \text{ mm}^2 / 24 \text{ AWG}$

#### Connecting by Opening the Connector

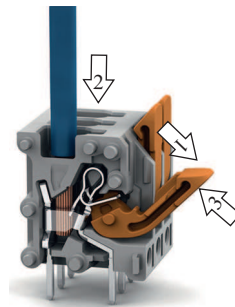

Figure 15: Wiring by Opening the Lever

The wiring requires no tools.

Proceed as follows:

1. Open the connection of the corresponding conductor using the orange-colored lever [1].

2. Insert the stripped conductor into the corresponding connection opening [2].
3. Use the lever to close the connection [3]. This secures the conductor.

### Disconnect the Wiring

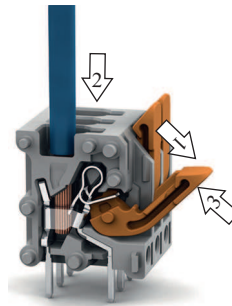

Figure 16: Disconnecting the Wiring

Proceed as follows:

1. Open the connection of the corresponding conductor using the orange-colored lever [1].
2. Remove the conductor from the corresponding connection opening [2].
3. Use the lever to close the connection [3].

#### **i Note**

#### **Connect only one conductor per CAGE CLAMP® connection!**

Only one conductor may be connected on each CAGE CLAMP® connection. Do not connect more than one conductor on one single connection.

If more than one conductor needs to be routed to one connection, connect them in an up-circuit wiring assembly – for example, using WAGO through terminal blocks.

# 8 Operation

## 8.1 Setting the Output Voltage via Potentiometer

The potentiometer (see  **Control Elements [▶ 15]**) on the front of the product can be used to set the output voltage in the range of 23 ... 28 VDC:

- Turning clockwise increases the output voltage.
- Turning counterclockwise decreases the output voltage.

### **Note**

#### **Operating Tool**

The recommended operating tool is: "Operating tool, Phillips PH0, type 1", Item No. 210-769.

# 9 Notes on Operation

## 9.1 Parallel Connection

In parallel operation, set the output voltage of the products that will be connected in parallel to precisely the same value, if possible. The resistance of the conductors between the product and the load must be nearly identical. Only connect products of the same type in parallel.

Use external rail-mount terminal blocks when connecting in parallel. A parallel connection directly on the connectors on the secondary side of the product is not allowed.

To decouple the outputs in parallel mode, a suitable redundancy module or diodes in the positive path are recommended. These diodes must be designed for the product's maximum output current.

# 10 Decommissioning

## 10.1 Disposal and Recycling

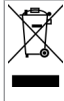

### WEEE Mark

Electrical and electronic equipment may not be disposed of with household waste. This also applies to products without this mark.

Electrical and electronic equipment contain materials and substances that can be harmful to the environment and health. Electrical and electronic equipment must be disposed of properly after use. Environmentally friendly disposal benefits health, protects the environment from harmful substances in electrical and electronic equipment and enables sustainable and efficient use of resources.

- Observe the national and local regulations for the disposal of electrical and electronic equipment, lithium-ion batteries, lead–acid batteries and packaging.
- Clear any data stored on electrical and electronic equipment.
- Remove lithium-ion batteries, lead–acid batteries or memory cards that are added to the electrical and electronic equipment.
- Wear appropriate personal protective equipment when removing the lithium-ion batteries/lead–acid batteries.
- Dispose of the removed lithium-ion batteries/lead–acid batteries according to your local waste regulations (e. g. collection boxes at the retail or local collection points).
- Have electrical and electronic equipment sent to a local collection point.
- Dispose of all types of packaging to ensure a high level of recovery, reuse and recycling.
- Transport packages from the B2B area can be taken back free of charge via a return system in accordance with the Packaging Act. Please contact our service provider Interseroh directly. The corresponding certificate can be found at: [🌐 corporate-certificates](#)
- Throughout Europe, Directives 2006/66/EC, 94/62/EC and 2012/19/EU (WEEE) apply. National directives and laws may differ.



# 11 Appendix

## 11.1 Accessories

Details on accessories are available online at [www.wago.com](http://www.wago.com).

The following accessories are available for the product:

### Accessories – Tools

Table 18: Accessories – Tools

Description	Name	Item Number
Operating tool for setting the potentiometer	Screwdriver PH0	210-769

### Accessories – Other

Table 19: Accessories – Other

Description	Item Number
Fuse terminal blocks for cylindrical fuses <sup>1)</sup> 10 × 38 mm	811 Series

<sup>1)</sup> Cylindrical fuses are not offered by WAGO.

### Accessories – Marking

Table 20: Accessories – Marking

Description	Item Number
Marking System	2009-110
WMB Multi Marking System	2009-115
	2009-115/000-002

## 11.2 Protected Rights

- Adobe® and Acrobat® are registered trademarks of Adobe Systems Inc.
- Android™ is a trademark of Google LLC.
- Apple, the Apple logo, iPhone, iPad and iPod touch are registered trademarks of Apple Inc. registered in the USA and other countries. “App Store” is a service mark of Apple Inc.
- AS-Interface® is a registered trademark of the AS-International Association e.V.
- BACnet® is a registered trademark of the American Society of Heating, Refrigerating and Air Conditioning Engineers, Inc. (ASHRAE).
- Bluetooth® is a registered trademark of Bluetooth SIG, Inc.
- CiA® and CANopen® are registered trademarks of CAN in AUTOMATION – International Users and Manufacturers Group e.V.
- CODESYS is a registered trademark of CODESYS Development GmbH.
- DALI is a registered trademark of the Digital Illumination Interface Alliance (DiiA).
- Docker® and the Docker® logo are trademarks or registered trademarks of Docker, Inc. in the USA and/or other countries. Docker, Inc. and other parties may also have trademark rights to other terms used herein.
- EtherCAT® is a registered trademark and patented technology licensed by Beckhoff Automation GmbH, Germany.
- ETHERNET/IP™ is a registered trademark of the Open DeviceNet Vendor Association, Inc (ODVA).

- EnOcean® is a registered trademark of EnOcean GmbH.
- **flexROOM**® is a registered trademark of WAGO Verwaltungsgesellschaft mbH.
- Google Play™ is a registered trademark of Google Inc.
- IO-Link is a registered trademark of PROFIBUS Nutzerorganisation e.V.
- KNX® is a registered trademark of the KNX Association cvba.
- Linux® is a registered trademark of Linus Torvalds.
- LON® is a registered trademark of the Echelon Corporation.
- Modbus® is a registered trademark of Schneider Electric, licensed for Modbus Organization, Inc.
- OPC UA is a registered trademark of the OPC Foundation.
- PROFIBUS® is a registered trademark of the PROFIBUS Nutzerorganisation e.V. (PNO).
- PROFINET® is a registered trademark of the PROFIBUS Nutzerorganisation e.V. (PNO).
- QR Code is a registered trademark of DENSO WAVE INCORPORATED.
- Subversion® is a trademark of the Apache Software Foundation.
- Windows® is a registered trademark of Microsoft Corporation.

# List of Tables

Table 1	Connectors.....	14
Table 2	Technical Data – Product.....	15
Table 3	Technical Data – AC Input.....	16
Table 4	Technical Data – DC Input.....	16
Table 5	Technical Data – Inrush Current.....	17
Table 6	Technical Data – Mains Failure Buffering Time.....	17
Table 7	Technical Data – Input Side Connection.....	17
Table 8	Technical Data – Output.....	17
Table 9	Technical Data – Contact Output.....	18
Table 10	Technical Data – Efficiency/Power Loss.....	18
Table 11	Technical Data – MTBF/Lifespan.....	19
Table 12	Technical Data – Environment requirements.....	19
Table 13	Technical Data – Product safety.....	20
Table 14	Technical Data – Safety.....	20
Table 15	Technical Data – Minimum Clearances.....	21
Table 16	Max. Values for horizontal installation.....	21
Table 17	Derating (Temperature-Dependent).....	21
Table 18	Accessories – Tools.....	33
Table 19	Accessories – Other.....	33
Table 20	Accessories – Marking.....	33

# List of Figures

Figure 1	View .....	12
Figure 2	Connection Input X1 .....	14
Figure 3	Connection Output X2 .....	14
Figure 4	Potentiometer .....	15
Figure 5	LED "Overload" and LED "DC OK" .....	15
Figure 6	Dimensions .....	16
Figure 7	Efficiency at 230 VAC .....	18
Figure 8	Power loss at 230 VAC .....	19
Figure 9	Derating (Temperature-Dependent) .....	22
Figure 10	Hiccup-Mode .....	22
Figure 11	Turn-on time .....	23
Figure 12	Position of the DIN Rail .....	25
Figure 13	Mounting the Product on the DIN rail .....	26
Figure 14	Removing the Product from the DIN Rail .....	26
Figure 15	Wiring by Opening the Lever .....	28
Figure 16	Disconnecting the Wiring .....	29



**WAGO GmbH & Co. KG**

Postfach 2880 · D - 32385 Minden  
Hansastraße 27 · D - 32423 Minden

✉ [info@wago.com](mailto:info@wago.com)  
🌐 [www.wago.com](http://www.wago.com)

Headquarters	+49 571/887 – 0
Sales	+49 (0) 571/887 – 44 222
Order Service	+49 (0) 571/887 – 44 333
Fax	+49 571/887 – 844169