



# MAXBAR+



## New Energy Protection Kit



[clipsal.com/MAX9](https://clipsal.com/MAX9)

Life Is On

Schneider  
Electric

## MAXBAR+

Ensuring electrical safety in the era of solar installations and electrification is the new challenge.

As the world moves towards a greener future, solar installation has become increasingly popular, enabling homeowners to harness clean energy from the sun. Over the years, advancements in solar technologies have made installations safer than ever before. However, it is crucial for both electricians and homeowners to adapt to the context of mass electrification to ensure electrical installations in home remain fully safe.

Here are the reasons why:

- 1. Growing electrification:** The rapid expansion of home electrification, driven by the increasing adoption of electric vehicles, heat pumps, and other energy-intensive appliances as part of the shift away from fossil fuels. This increased electrical demand leads to a heavier load on our electrical systems, requiring careful consideration to prevent overload and associated risks.
- 2. Existing switchboard challenges:** Many older homes have electrical switchboards that may not be equipped to handle the additional load from solar production and home electrification. This can lead to overheating, damage, and potential fire hazards. Upgrading switchboards or implementing load management strategies may be necessary to mitigate these risks.
- 3. Multiple energy sources:** The adoption of solar and battery systems in Australian homes is on the rise. With the integration of multiple energy sources, electricians are now tasked with assessing the overall current capacity of the electrical system and ensuring that the circuit protection can effectively safeguard against extreme demand scenarios.

When it comes to electrical safety, homeowners place their trust in electricians to provide solutions that will safeguard their homes both now and in the future. It is now more crucial than ever to plan and future-proof clients' homes, considering the rise of renewable energy and heavy energy-intensive electric loads.

**Introducing Clipsal MAX9 new energy protection kits with MAXBAR+.** These innovative kits offer a comprehensive solution, combining circuit protection, busbar, and accessories to effectively tackle the challenges posed by renewable energy and home electrification. The MAXBAR+ busbar is designed to efficiently group multiple energy sources onto one busbar and distribute power to the general loads of the house.



## Features and benefits:

- **MAX Protection:** MAXBAR+ busbar helps protect switchboards against overloading from bi-directional and multiple energy sources whilst also preventing potential hazards and hot joints associated from large feeding cables required for solar, battery, and EV charging.
- **MAX Future-ready:** MAXBAR+ ensures dedicated space in switchboard for solar, battery, and EV charging.
- **MAX Speed:** Faster installation by using a busbar instead of traditional cabling method.
- **MAX Professionalism:** Busbars enable installations to be neat and tidy by reducing feeding cables and providing more professional looking switchboards.
- **MAX Ease:** Easy to understand pictograms help to ensure correct placement of protection devices.



### MAX Ease

Pictograms help to ensure correct placement of protection devices

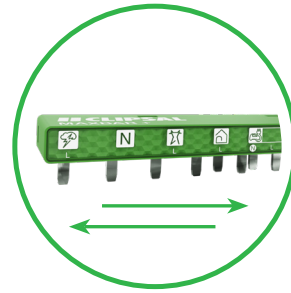

### MAX Protection

Helps protect for multiple energy sources



### MAX Future-ready

MAXBAR+ ensures dedicated space in switchboard for solar, battery, and EV charging

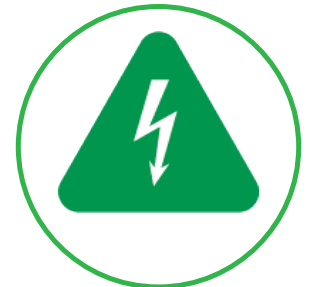

### MAX Protection

Helps prevent hot joints associated from large feeding cables

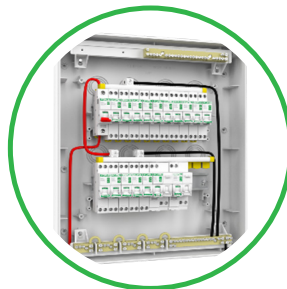

### MAX Professionalism

Neat and tidy switchboards by reducing large feeding cables for solar, battery, and EV charging circuits

## MAXBAR+ kit definition and breakdown

MAXBAR+ kits consist of a combination of busbar specifically designed for new energy applications, MCB's for grid supply, solar, and battery connections, RCBO sized for EV charging, and neutral terminal block for simple neutral distribution.

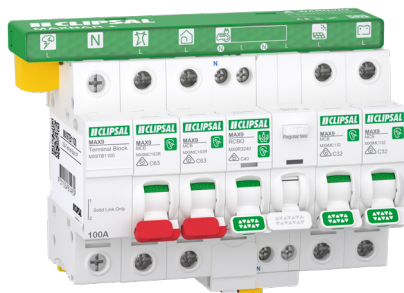

MAXBAR+ kit for single phase applications

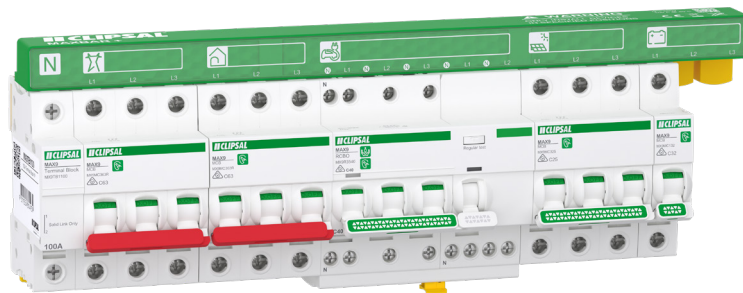

MAXBAR+ kit for 3-phase applications

Kit reference	Description	Commercial reference	Component short description	Quantity	Application
MX9K108PP	MAXBAR+ kit 1P	-	MAXBAR+ Busbar 1P 8 Mod	1	Distribution of energy sources
		MX9TB1100	MAX9 NTB	1	Neutral connection
		MX9MC163R	MAX9 1P MCB 63A Red Toggle	2	Grid supply and home circuits
		MX9R3240	MAX9 2 Mod RCBO 40A	1	EV charging circuit
		MX9MC132	MAX9 1P MCB 32A	2	Solar and battery circuits
		-	Busbar tooth cover	2	To be used when SPD or battery MCB not required.
		-	Sticker label sheet	1	To be used to identify MAXBAR+ circuits on enclosure cover. Option to replace battery circuit with either sub board or second solar circuit.

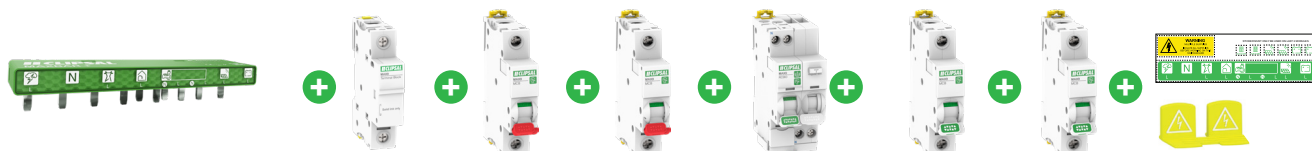

MX9K318PP	MAXBAR+ kit 3P	-	MAXBAR+ 3P 18 Mod	1	Distribution of energy sources
		MX9TB1100	MAX9 NTB	1	Neutral connection
		MX9MC363R	MAX9 3P MCB 63A Red Toggle	2	Grid supply and home circuits
		MX9R3540	MAX9 5 Mod RCBO 40A	1	EV charging circuit
		MX9MC325	MAX9 3P MCB 25A	1	Solar circuit
		MX9MC132	MAX9 1P MCB 32A	1	Battery circuit
		-	Busbar tooth cover	3	To be used when battery MCB not required
		-	Sticker label sheet	1	To be used to identify MAXBAR+ circuits on enclosure cover. Option to replace battery circuit with either sub board or second solar circuit



# MAXBAR+ technical data

Main characteristics	
Rated current (for busbar)	100 A at 40 °C
Rated voltage	240/440 V
Rated insulation voltage	500 V

## Catalog number format and legend

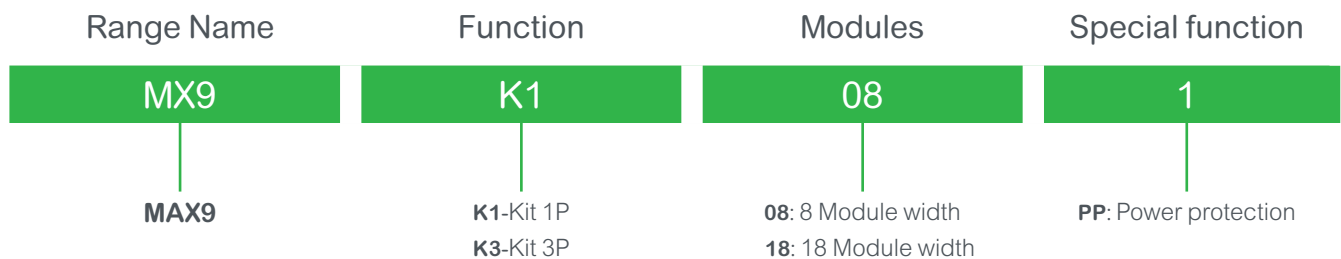

## Standard busbar vs MAXBAR+

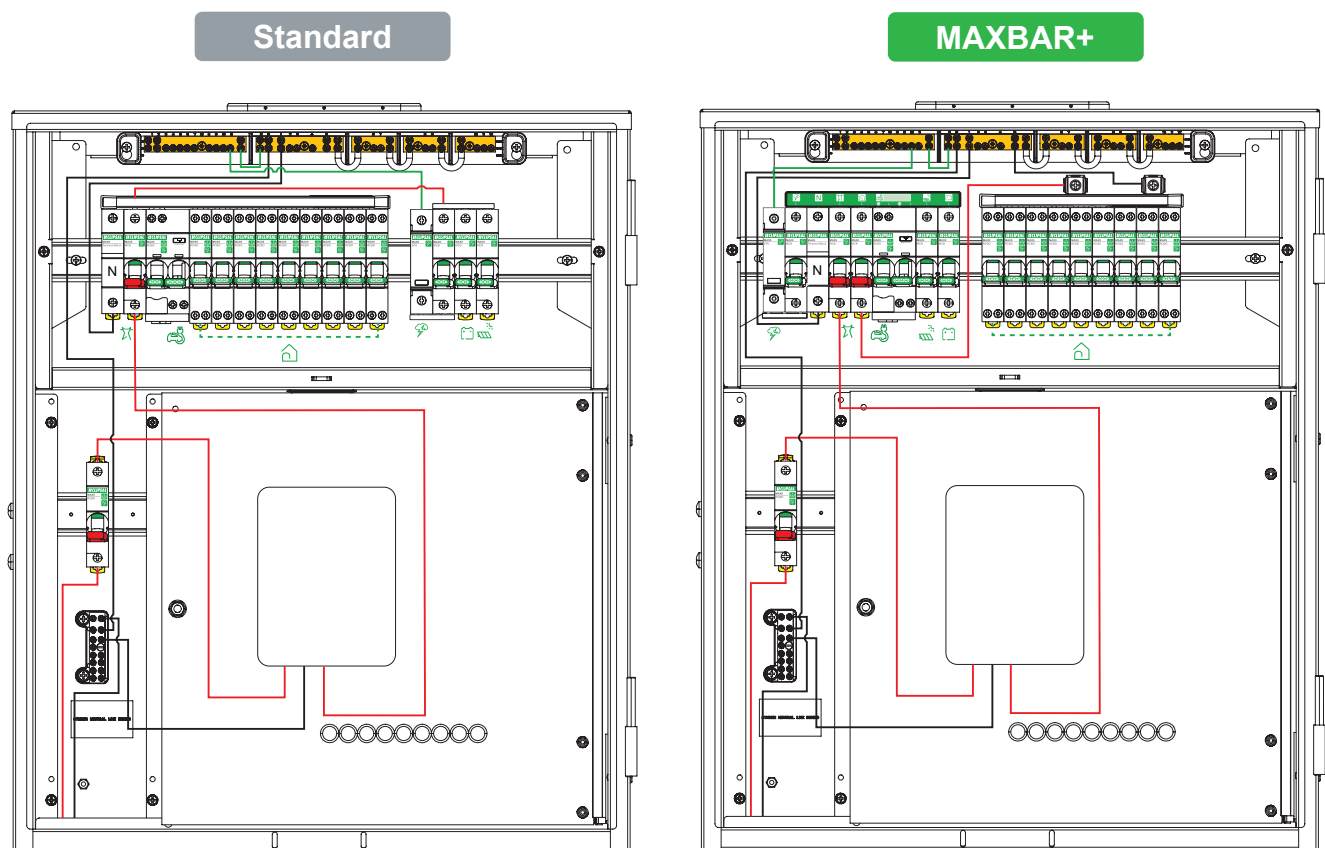

\*230DRAS1MI meter box shown for illustration purposes only

# How does MAXBAR+ work?

With multiple energy sources entering a switchboard in electrified homes, current flow inside the board will vary depending on time of day and usage.

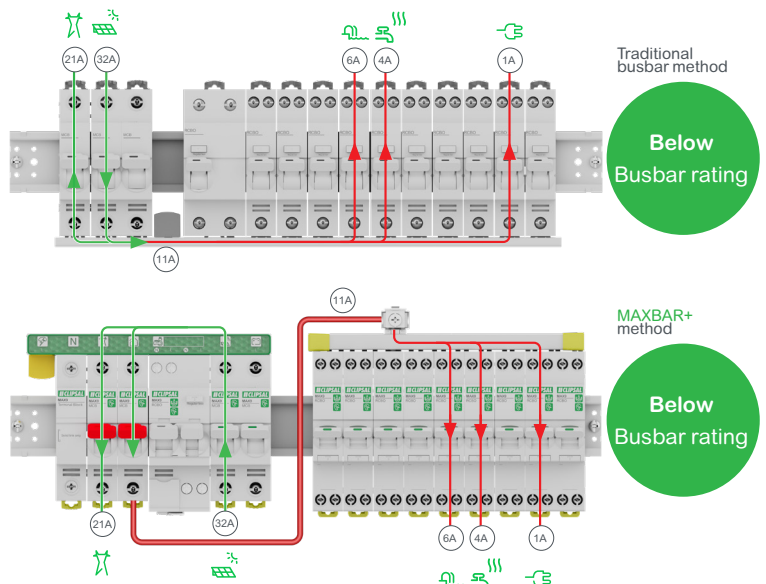
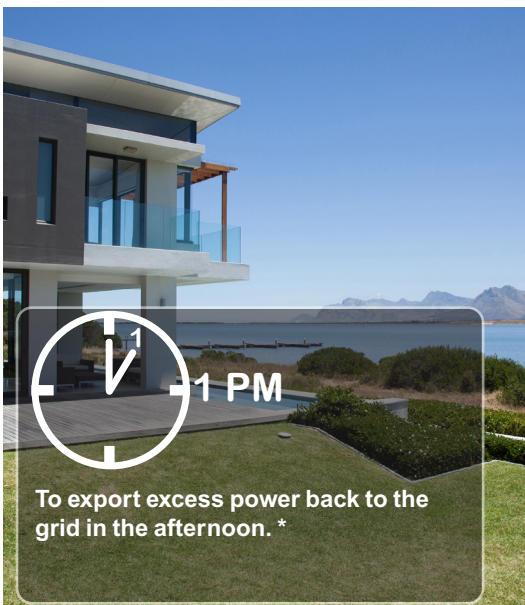
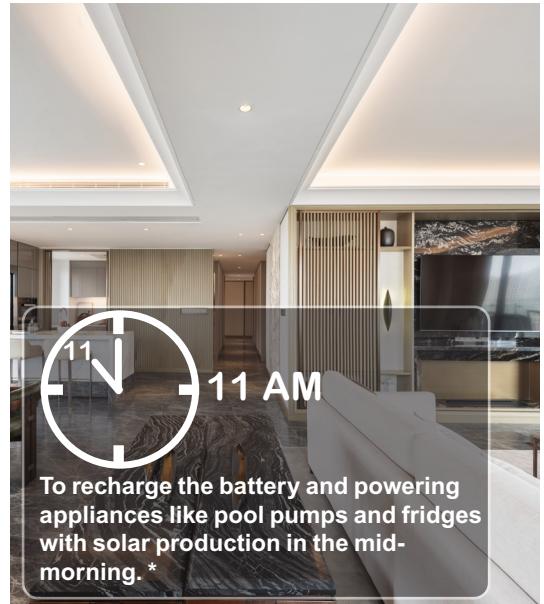
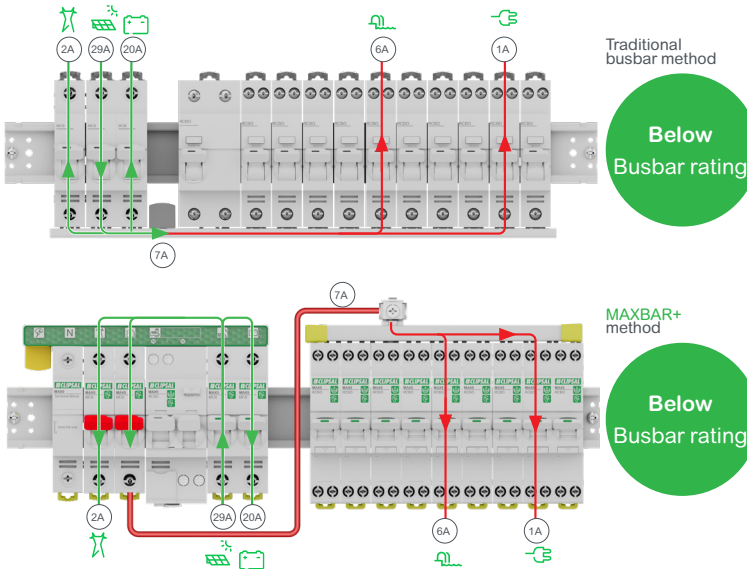
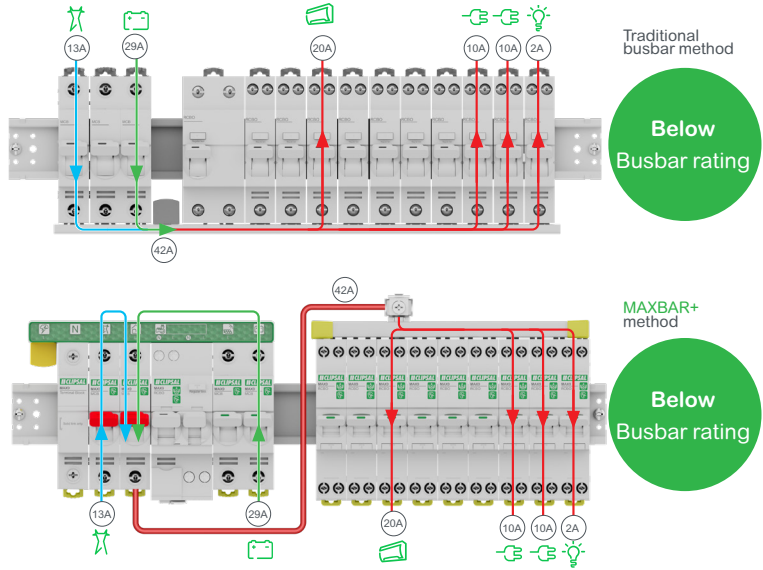
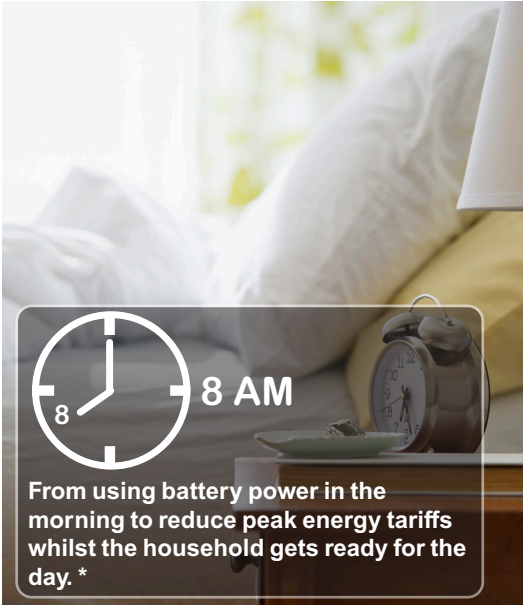

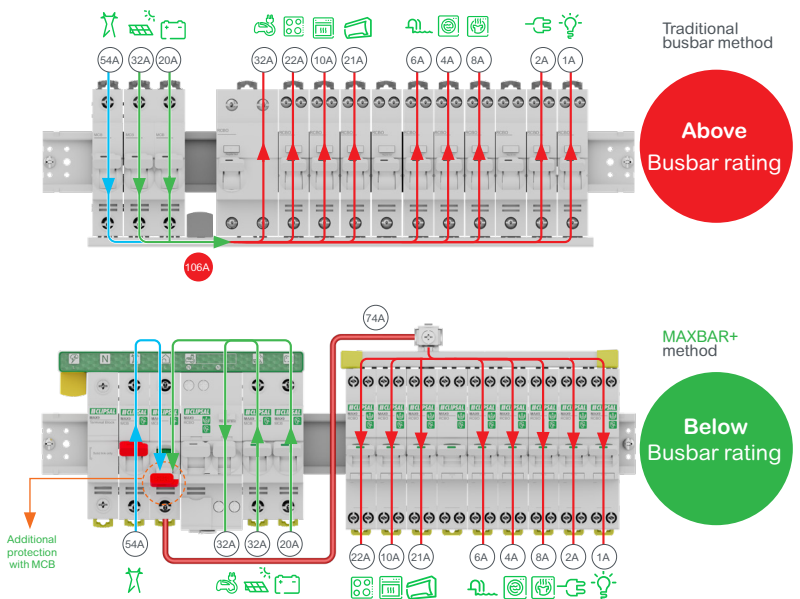
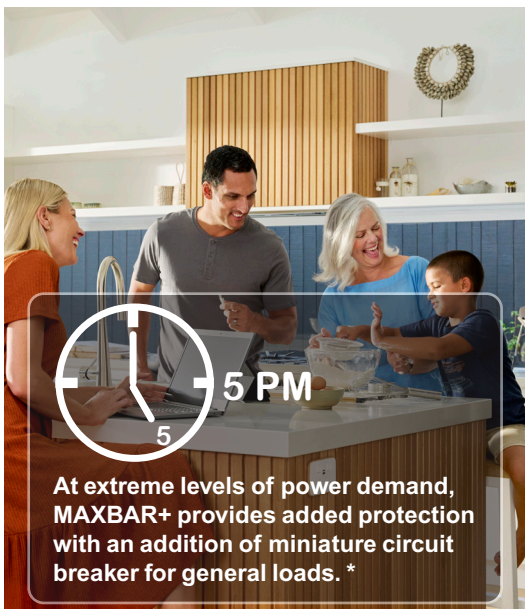
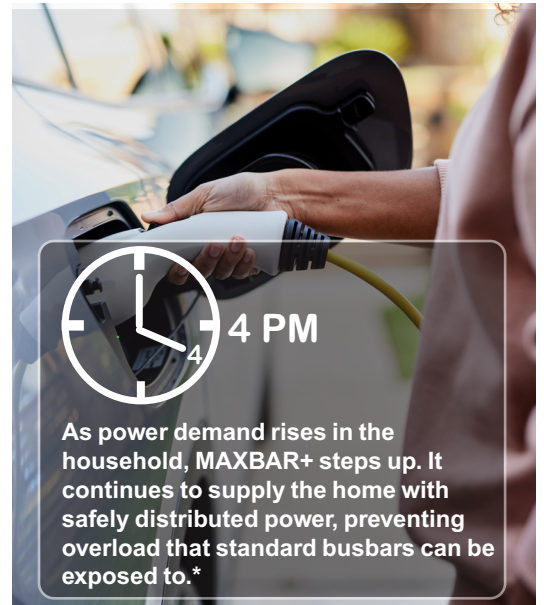
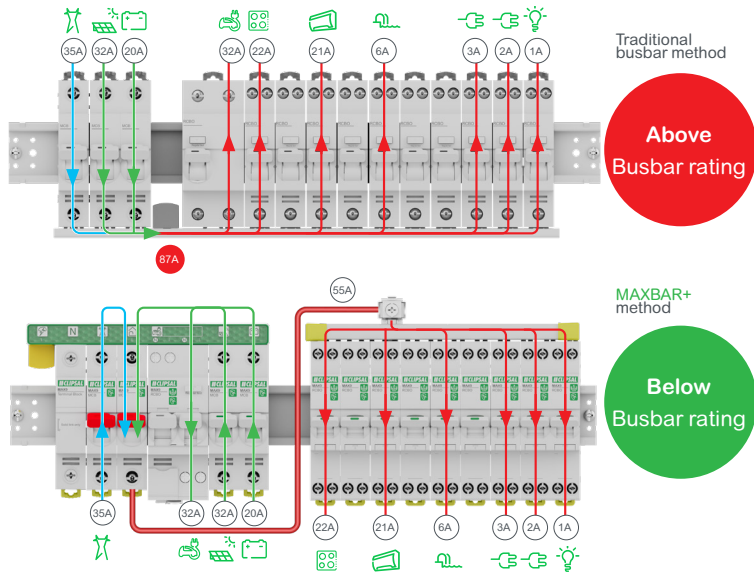

The pictograms on the front of MAXBAR+ are crucial for correctly placing circuits along the busbar. This ensures that grid supply and alternate energy sources are positioned at opposite ends of the busbar, while the home's general loads are placed in the middle. By doing so, MAXBAR+ helps to keep current flow within busbar rating, even during peak power demands.

MAXBAR+, ensuring residential switchboards are ready for the new energy transition.

### Pictogram legend

Grid supply	Solar supply	Battery supply	Electric Vehicle charging	Stove	Oven	Air conditioning	Pool pump	Washing machine	Dryer	General power outlets	Lighting

### Power flow legend

	Power consumed by loads
	Power supplied by grid
	Power supplied by renewable sources

\* Current flow scenarios for indicative purposes only

For more information about MAX9 and other Clipsal products, contact your local Clipsal and Schneider Electric Representative, electrical wholesaler, or visit: [clipsal.com/MAX9](https://clipsal.com/MAX9)

Schneider Electric (Australia) Pty. Ltd.  
33-37 Port Wakefield Road,  
Gepps Cross, South Australia, 5094  
PO Box 132, Enfield Plaza,  
South Australia, 5085  
[www.clipsal.com](https://www.clipsal.com)

Consumer Support Enquiries  
Phone: 1300 669 925  
Website: [clipsal.com/contactus](https://clipsal.com/contactus)  
National Customer Care (Trade only)  
Phone: 1300 369 233

06-2024  
CX901000

© 2024 Schneider Electric. All Rights Reserved. Clipsal are trademarks of Schneider Electric (Australia) Pty Ltd.



[clipsal.com/MAX9](https://clipsal.com/MAX9)

Life Is On

